

MADE IN ITALY

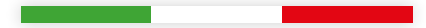

CREATIVITY_TECHNOLOGIES_MATERIALS
High-performance electrical connections

*Partner
for top
performance*



RETAIL PACKAGE (KIT)

*Connection of street lighting LED
Luminares (Rome, Italy). Series TH405.*



High-protection solutions



In-line Circular joint connectors

Ideal for connections in small spaces and with a high degree of protection (IP68).



Quick, Re-accessible and Compact

Using the fewest number of components, we ensure that the product is installed in an easy way and in the least possible time.

Totally resin and gel-free, our TEETUBE® solutions are re-accessible even after long operating periods.

Availing ourselves of an innovative design and maximum precision in thermoplastic injection, we realize solutions which are considerably compact, with a high number of poles.



High-protection solutions



Gasket co-molding

The quality of our materials, innovative proprietary technologies and an accurate analysis of the operative conditions of application allow us to realize and test solutions for electrical connections under the most extreme conditions. Therefore we have decided to supply the market with a revolutionary solution aimed to eliminate the resin sealing of boxes and connectors: **to mold the entire connector in only one solution.**

High-quality materials

UL94 V0/V2 (f1) materials are suitable for underground installation and guarantee reliability over time.

Products tested up to 10 years.

UV radiation resistant

UV radiation resistance test according to EN60079-0. Light ageing method (ISO 4892-2). Duration 1000 hours. Electrical insulation test up to 3.75kV.

Anti-leakage gaskets

Perfect chemical-mechanical adherence of gaskets which guarantee robustness and reliability in water tightness. **No more installation faults.**



Resistance to permanent immersion (IP68)



High-protection solutions



No more condensation: completely insulated and sealed

Under particular environmental conditions, the accumulation of moisture inside the cable can cause the malfunctioning of electrical devices. The ventilation of the device is not often possible, especially when there is water, debris or in very small spaces. In this case the electrical connection is fundamental to ensure the reliability of the system.

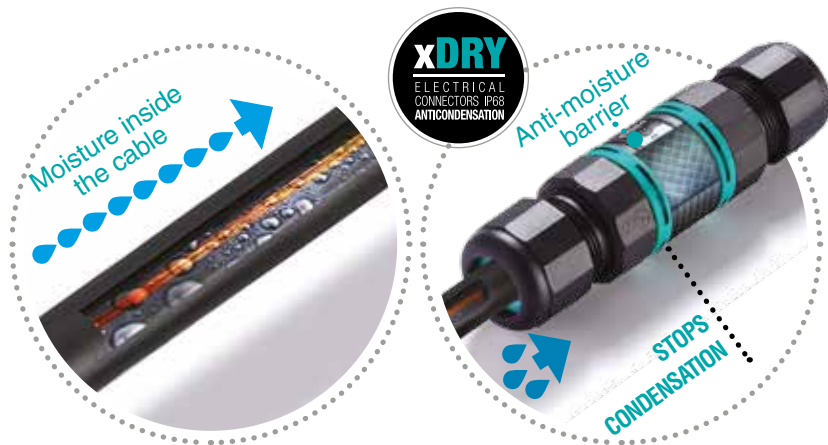

Reliability guaranteed under extreme conditions

The special anti-moisture barrier prevents the damp inside the cable from entering the connection and proceeding towards the device installed. TEETUBE® connectors are ideal for LED applications with the presence of water and debris (e.g. flooded junction boxes).

LED lighting, architectural, walkable, water submersion, fountains and swimming pools, trade fair stands, lighting displays, big areas.

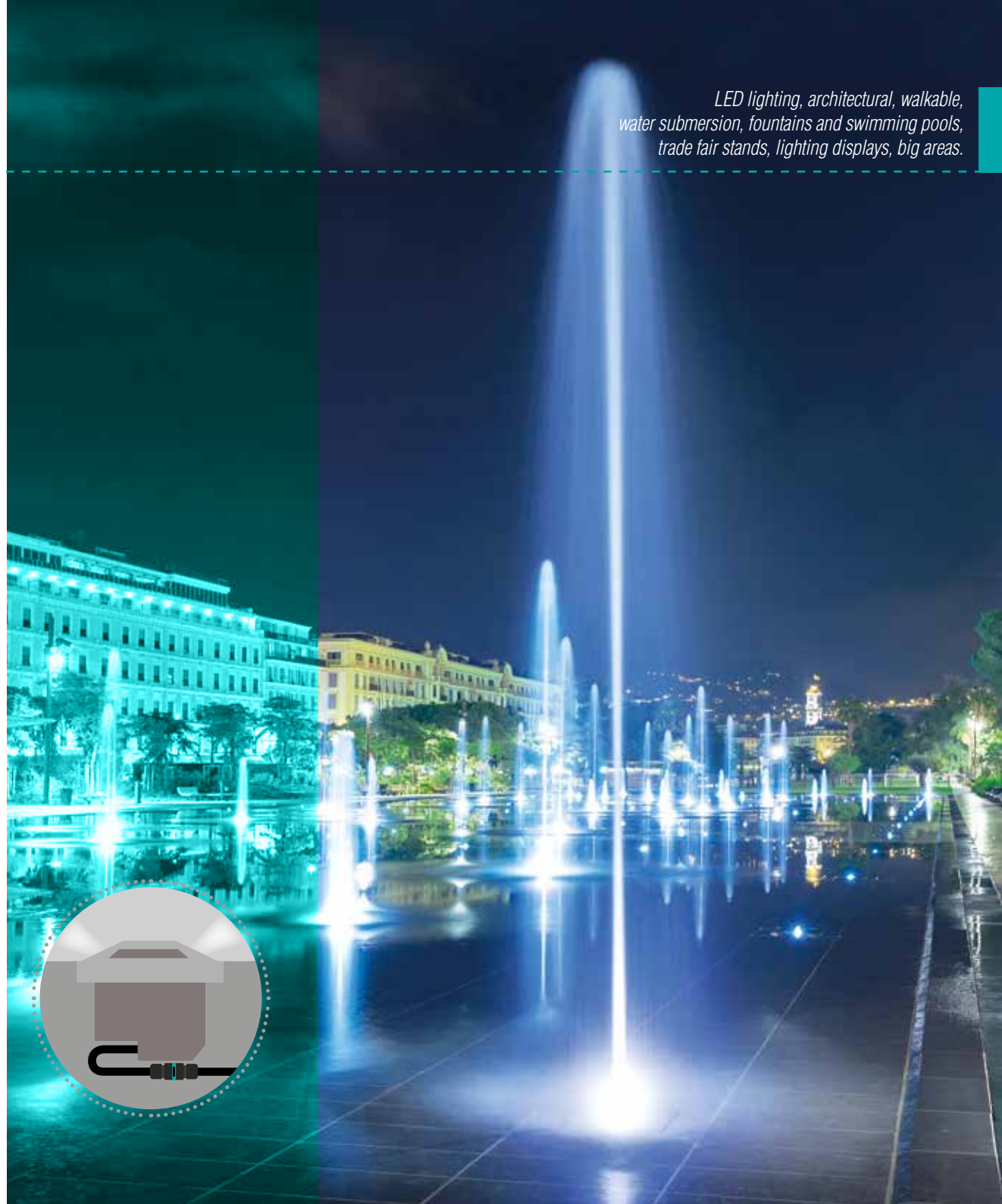

High-protection solutions



Useful for total protection

TEETUBE® connectors can be used in the most various situations, for example in the connection of power and heating cables, as a protection of electronic circuits, in data and optical fiber connections, in motors and pumps.

RESIN-GEL FREE



IP68



Simplified installation:

Pre-wired solutions. It is not necessary to open the box and realize complex wiring.

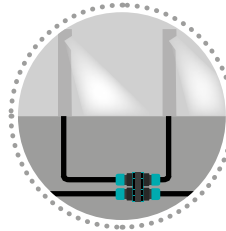

Submersible pumps and engines. Connectors and junctions IP68, resistant to moisture.



Wiring in shipbuilding and cooling containers.



Heating cables connection.

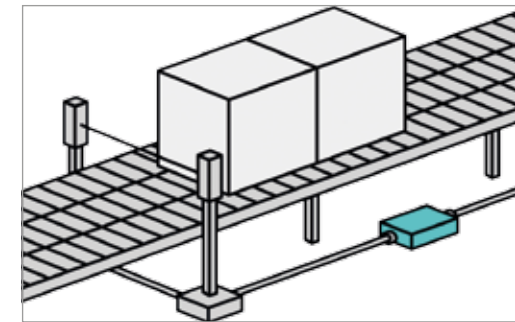

Quick connection junctions for industrial machines.

High-protection solutions



Quick plug&socket connectors

High-performance cable, wall mount and special connectors (IP68).



Robust and safe

The quick bayonet coupling junction ferrule with **safety lock-unlock system** guarantees higher resistance to vibrations and mechanical stresses (**guarantee of electrical continuity**). The disconnection is possible only by the use of a tool to prevent accidental displacement.

Maximum resistance to tensile stress

Under adverse installation conditions (e.g. heavy embossed cables, strong impacts, vibrations, etc.), a special cable block-system ensures perfect resistance to stresses (e.g. tensile stress).



Powerful and compact

The TEEPLUG® family is characterized by quick plug&socket connection solutions up to 25A 400V. Their compact dimensions are a strong point as an alternative to big industrial sockets with their electrical characteristics being the same.



Total protection

To ensure better seal, two gaskets have been co-molded on the diameter and on the bottom of the connector to prevent water and dusts from penetrating it. The gaskets are anti-leakage.



High-protection
solutions



Maximum efficiency in installation and maintenance

The plug&socket connectors and quick junction boxes constitute a reliable modular interconnection system which is necessary to guarantee flexibility and quickness in the configuration of a more and more advanced plant. **Reduction of cost of the product installed.**



Lighting of the F1 circuit in Singapore with TH405 connectors.

Public lighting, urban furniture, smart city, CCTVs, data centers, electric signs, car charging stations, etc.

Our materials do not contain sulfur which has a negative effect on the LED lifespan.



High-protection solutions



Dimensions that make the difference

Compact screw wire connectors meet the most demanding needs of connections in small spaces.



Ultra flat connector.

It is the only 4mm thick connector IP67 on the international market. It has been specifically designed and produced to be used in floor heating plants.

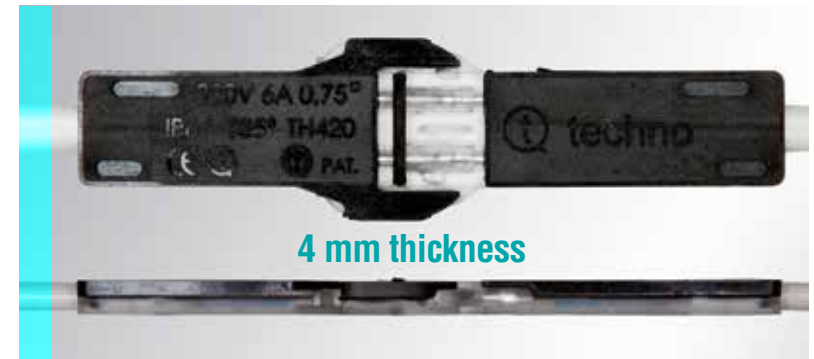

-60%
Faster
installations

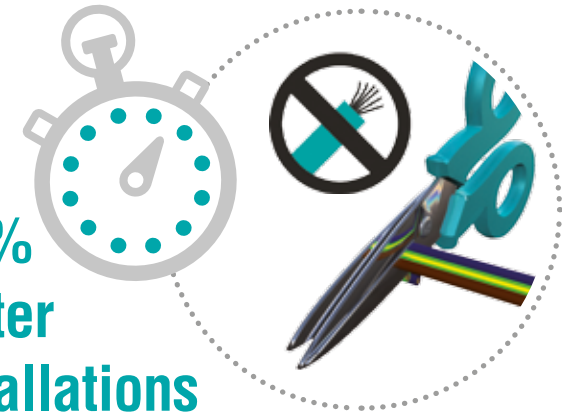

Quick screw wire and piercing connectors

The wire does not need to be peeled. It is enough to cut the wire and insert it into the wiring terminal. The golden colour screw identifies the insulation piercing connectors. We have available also connectors with standard screw terminal, metal and spring terminal.

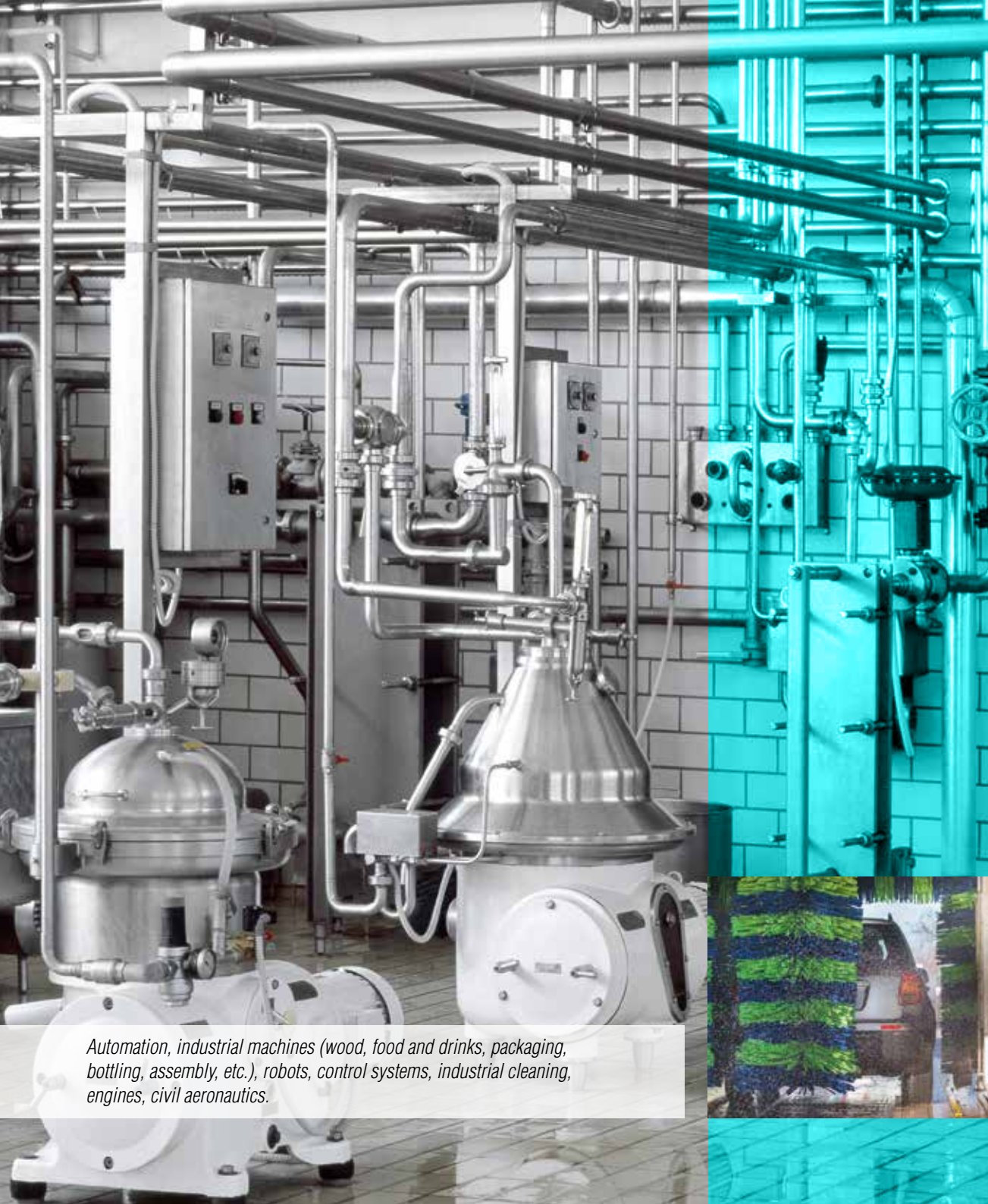

Reliable under extreme conditions

We rely on materials and productive technologies of excellence. We perform stress tests on our products, in addition to the ones provided for by law, to obtain an extremely high level of resistance to moisture, water, dusts and aggressive chemicals. UL94 V2/V0 Yellow Card materials: their exceptional mechanical, temperature and temperature gradients resistance increases the advantages of use further in many sectors.

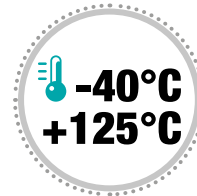

Automation, industrial machines (wood, food and drinks, packaging, bottling, assembly, etc.), robots, control systems, industrial cleaning, engines, civil aeronautics.



High-protection solutions



Junction boxes and current distributors

Junction boxes with terminal blocks and plug&socket connectors for quick and flexible installations (IP68).



Attention to minute details

The co-molding gasket guarantees fail-safe installations. The connection hinge between the top and the bottom, obtained directly from the molding of the product, simplifies the installation activities. Cable glands with milled claws built in the box allow the installation of small-section cables.



High-protection solutions



Protected and compact for maximum versatility

Junction boxes approved up to IP68 guarantee water and dust proof connections without the use of resin or gel.

The boxes are re-accessible thanks to their compact dimensions, they are particularly suitable for connections in small spaces or containing electronic and electromechanical components.

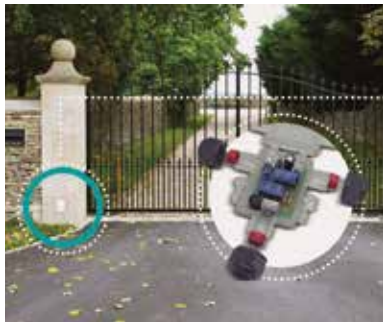

Residential and industrial electrical installation, junction boxes, gates and doors automation, CCTVs, heating/air-conditioning.



The highest performance in small space



Resistance to external agents (EN60529). In addition: ageing test in air with ozone concentration (ISO1431-1).



Resistance in saline environment - Corrosion test (EN60068-2-11:2000).



Resistance to impact (NEMKO - EN62262:2002). IK08 and IP68 tests satisfactory even after conditioning in hydrochloric acid (HCl) for 168 hours at 70°C (pH 4,5 and 3,5). Available versions with IK10.

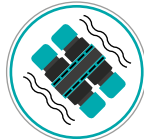

Resistance to vibrations (DEKRA - EN 60068-2-6; RINA RULES 2011 Pt C, Ch 3, Sec 6).



Resistance to flame. Use of materials reinforced with fiberglass UL94 V0/V2 (f1). Glow-wire 850°C/960°C.



Realized with materials compliant with the most rigorous Reach/RoHs regulations.

Upon request: low-smoke materials, EMC materials, resistant to ammonium versions. Search for materials and internal laboratory tests upon customer's specification.

Water treatment, monitoring, submersible pumps, energy distribution, petrol stations, mines, processing plant, irrigation, agriculture and cultivation, greenhouse.



Resistant to hydrocarbons (tested according to ISO1817:2001)



High-protection
solutions



Higher flexibility in the configuration of complex plants

3 and 4 ways electrical current distributors (pre-wired boxes with plug&socket connectors) designed to speed up the connection and disconnection of electrical networks and devices of various kind. The access to the terminal block inside the box is not required: it takes advantage of the simplicity and flexibility of a plug&socket connection.

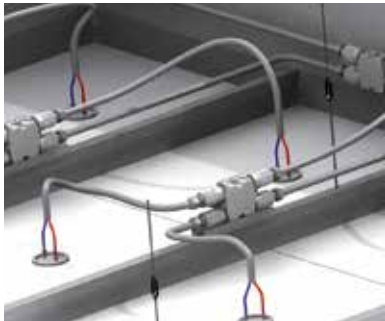

*Railway, tram, underground, bus,
navigation, shipbuilding, marine lighting,
yacht, caravan, light signaling, cable car.*

Cable tying solutions



Innovative cable glands in co-molding

High-protection cable glands (IP68) for quick cable tying.

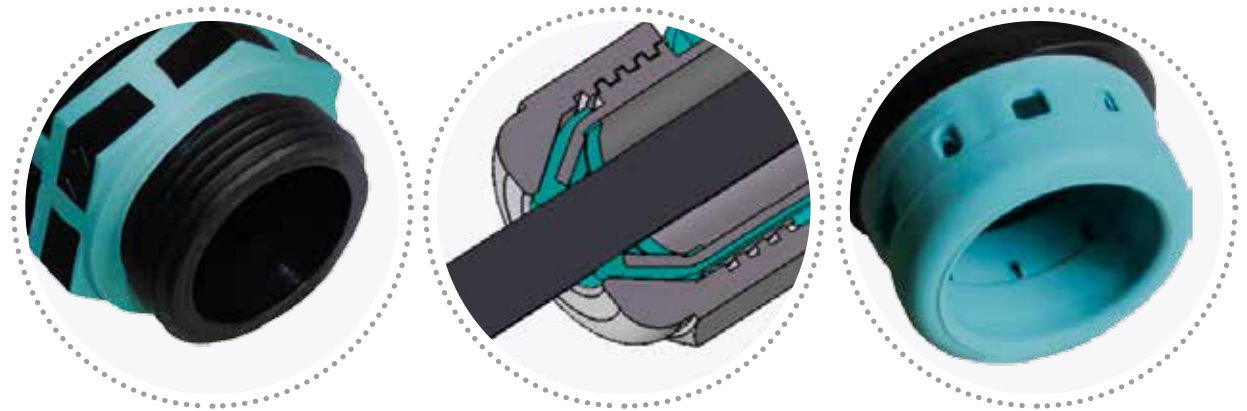

Rigorously reliable

Attention to details

The protective rubber is co-molded also where the cable gland is in contact with any supports. This gives it further reliability and safety, avoiding the use of OR on the thread of the cable gland.

The internal circular rubber crown ensure perfect tightness on the cable. A cable grommet is not needed anymore. Water tightness is guaranteed even in case of excessive nut tightening.

**max
55N**

Approved according to **EN50262**.
Cable tensile test **max.55N** passed.

**-50m
(5bar/1h)**

IP68



More quickness

The use of the TEEGLAND® cable gland allows a considerable saving on installation time. The fastening of the cable and the installation of the cable gland on the panel take only 2-steps and less than 8 seconds.

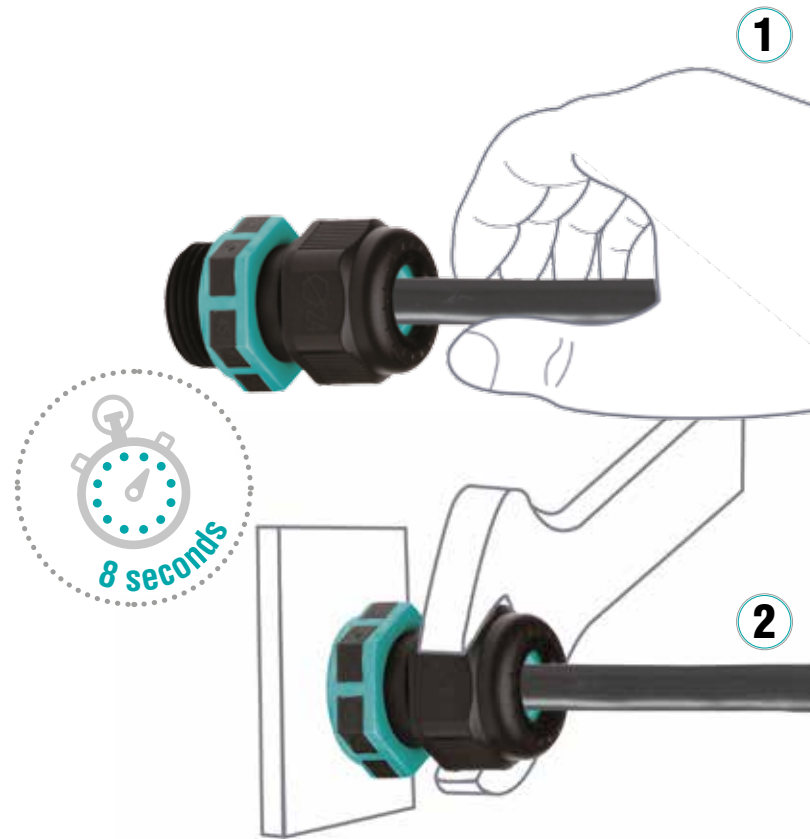

Fewer assembly faults

The co-molding of the rubber on the techno polymer ensures perfect installation compared to standard cable glands, where the detachment or the wrong position of the gaskets can impair its functioning. The rubber adheres chemically and mechanically to the plastic body and guarantees valid protection from external agents (IP68).

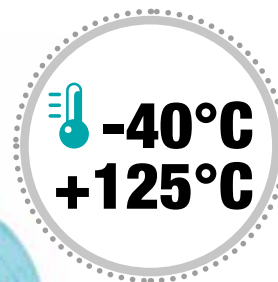

Engines and pumps, heating, air-conditioning, ventilation, industrial refrigerators, SPA, hydro-massage, vending.



Compact circular connectors

Individually usable or with TEETUBE® circular joint connectors.

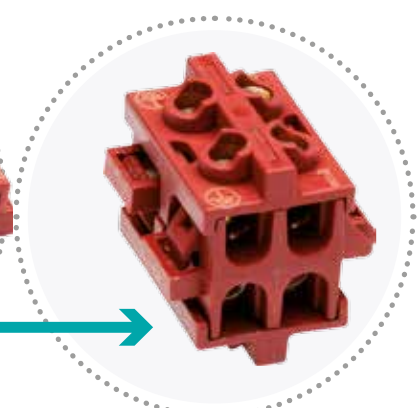
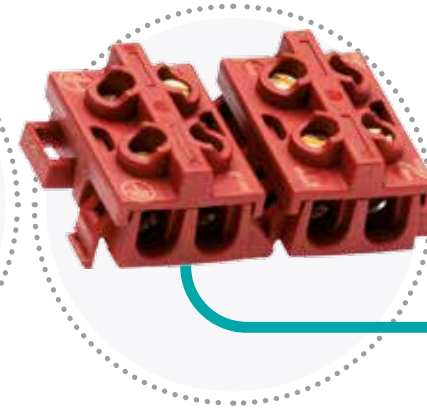

Modular and compact

Circular connectors, more compact than standard terminal blocks with the same number of poles.

Useful and versatile

The 4-way terminal block with a hinge makes cable wiring easier in particular situations such as automatic screwing in an industrial process.

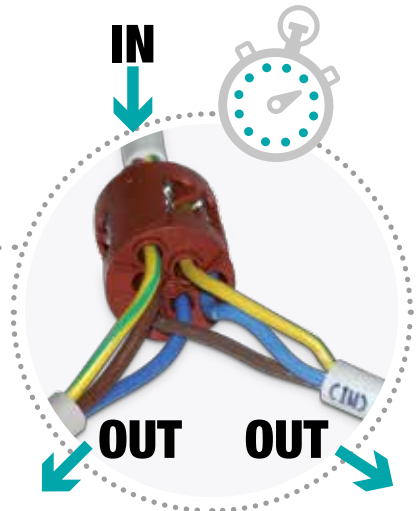
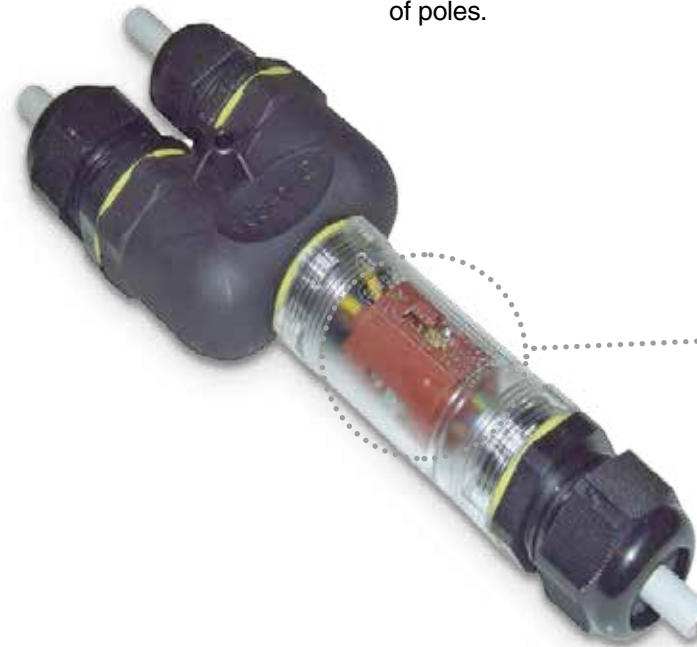

Connection solutions



Compact linear connectors

Individually usable or with TEEBOX® junction boxes.

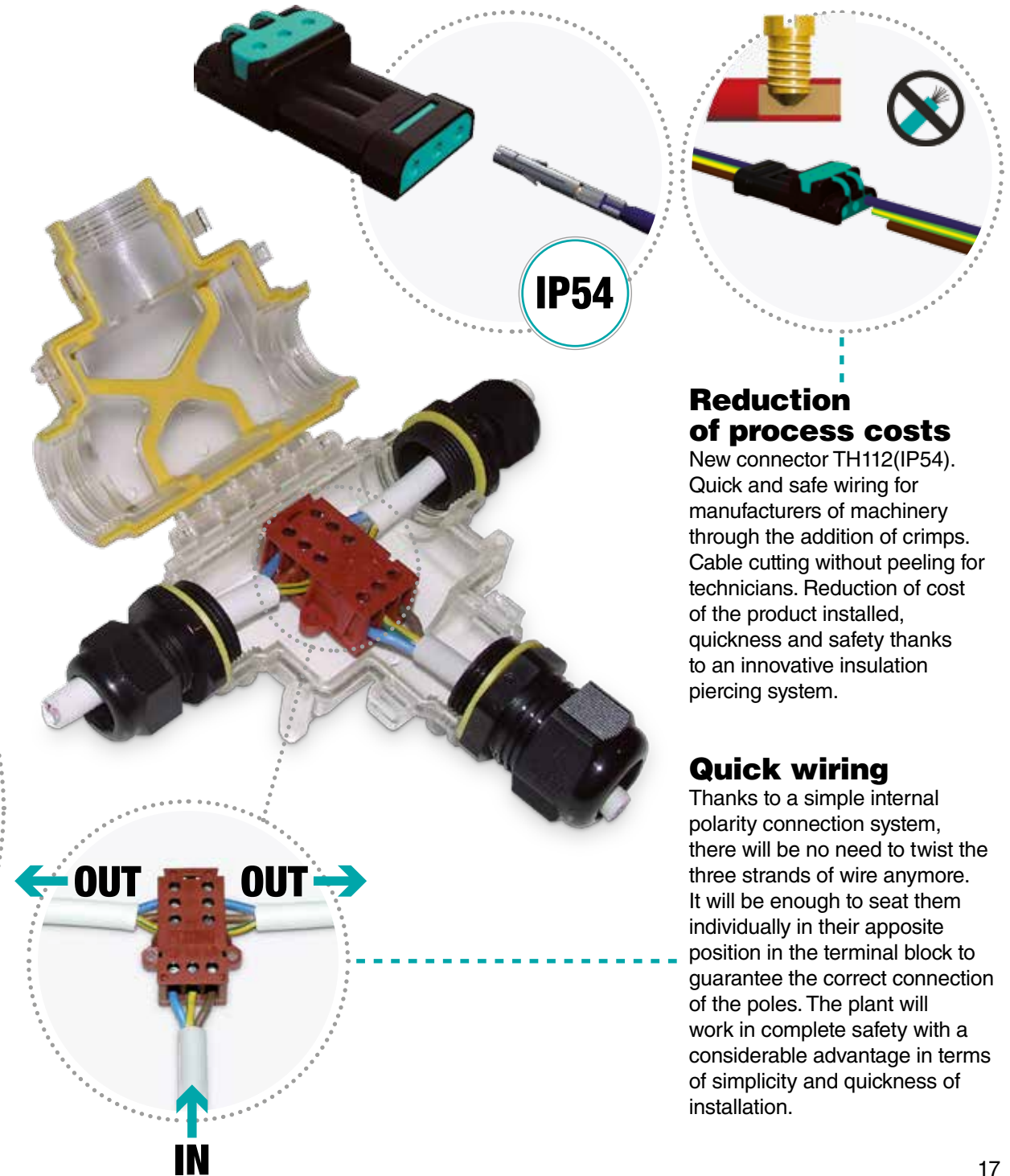
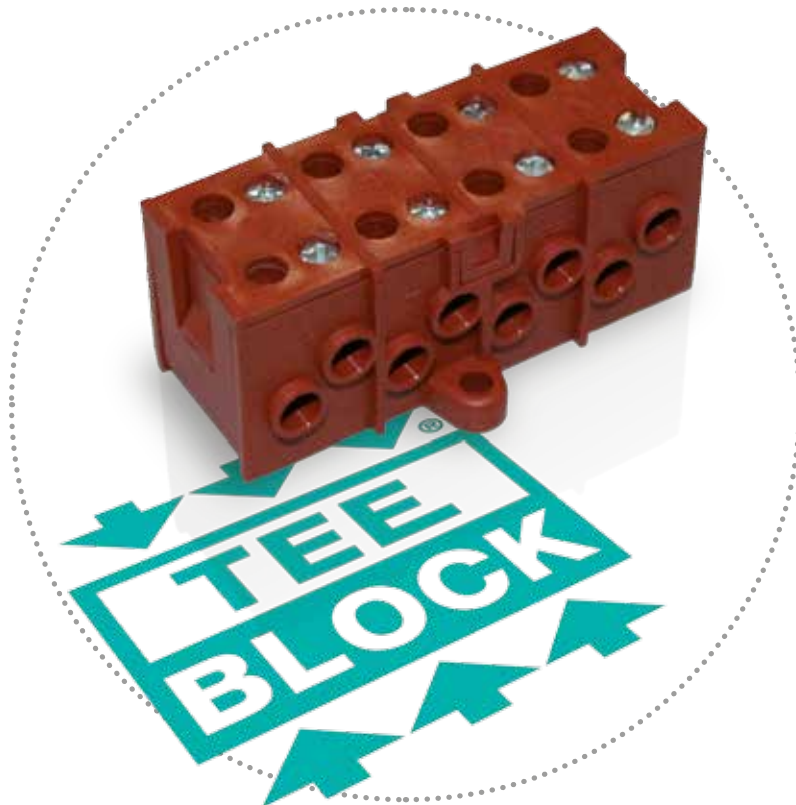

IP54

Reduction of process costs

New connector TH112(IP54). Quick and safe wiring for manufacturers of machinery through the addition of crimps. Cable cutting without peeling for technicians. Reduction of cost of the product installed, quickness and safety thanks to an innovative insulation piercing system.

Quick wiring

Thanks to a simple internal polarity connection system, there will be no need to twist the three strands of wire anymore. It will be enough to seat them individually in their apposite position in the terminal block to guarantee the correct connection of the poles. The plant will work in complete safety with a considerable advantage in terms of simplicity and quickness of installation.



High-performance electrical connections TEEfamily® IP68

Fixed connectors (re-accessible)



In-line connectors

Number poles⁽¹⁾
Wire cross-section
Outer cable diameter⁽²⁾
IP protection degree

| | | | |
|---------------------------|---------------------------|---------------------------|---------------------------|
| | | | |
| TH391 | TH390 | TH400 | TH110 |
| 2 4 poles | 2 3 poles | 2 6 poles | 2 3 poles |
| 0.5 - 4.0 mm ² | 0.5 - 4.0 mm ² | 0.5 - 6.0 mm ² | 0.5 - 2.5 mm ² |
| 5.0 - 12.0 mm | 6.0 - 13.5 mm | 6.0 - 17.0 mm | 5.0 - 9.0 mm |
| IP68 | IP68 | IP68 | IP44 |

Plug&Play connectors



| | | | |
|---------------------------|---------------------------|---------------------------|---------------------------|
| | | | |
| TH387 | TH384 | TH404 | TH405 |
| 2 5 poles | 2 3 poles | 2 6 poles | 2 6 poles |
| 0.5 - 2.5 mm ² | 0.5 - 2.5 mm ² | 0.5 - 2.5 mm ² | 0.5 - 2.5 mm ² |
| 5.0 - 12.0 mm | 5.0 - 12.0 mm | 6.0 - 14.0 mm | 6.0 - 14.0 mm |
| IP68 | IP66/IP68 | IP65 | IP68 |

Junction connectors

3 ways

Number poles⁽¹⁾
Wire cross-section
Outer cable diameter⁽²⁾
IP protection degree

| | | | | | | |
|---------------------------|---------------------------|---------------------------|---------------------------|---------------------------|---------------------------|---------------------------|
| | | | | | | |
| TH390 | TH402 | TH399 | TH200 | TH211 | TH631 | TH370 |
| 2 3 poles | 2 6 poles | 2 6 poles | 2 3 poles | 2 4 poles | 2 6 poles | 2 poles |
| 0.5 - 1.5 mm ² | 0.5 - 4.0 mm ² | 0.5 - 4.0 mm ² | 0.5 - 1.5 mm ² | 0.5 - 4.0 mm ² | 0.5 - 2.5 mm ² | 2.5 - 6.0 mm ² |
| 6.0 - 13.5 mm | 6.0 - 17.0 mm | 6.0 - 17.0 mm | 2.5 - 9.5 mm | 6.0 - 17.0 mm | 6.0 - 14.0 mm | 6.0 - 8.0 mm |
| IP68 | IP68 | IP68 | IP67 | IP65 | IP65 | IP68 |

4 ways

Number poles⁽¹⁾
Wire cross-section
Outer cable diameter⁽²⁾
IP protection degree

| | | |
|---------------------------|---------------------------|---------------------------|
| | | |
| TH392 | TH209 | TH623 |
| 2 4 poles | 2 8 poles | 2 3 poles |
| 0.5 - 1.5 mm ² | 0.5 - 4.0 mm ² | 0.5 - 2.5 mm ² |
| 5.0 - 12.0 mm | 6.0 - 14.0 mm | 5.0 - 12.0 mm |
| IP68 | IP68 | IP68 |

Choose the connector that best suits your needs.

Wall mount connectors

Number poles⁽¹⁾
 Wire cross-section
 Outer cable diameter⁽²⁾
 IP protection degree

Fixed connectors (re-accessible)



TH391
 2 4 poles
 0.5 - 4.0 mm²
 5.0 - 12.0 mm
 M20-M25
 IP68

Plug&Play connectors



TH387
 2 5 poles
 0.5 - 2.5 mm²
 5.0 - 12.0 mm
 M20-M25
 IP68



TH385
 2 3 poles
 0.5 - 4.0 mm²
 5.0 - 12.0 mm
 M20-M25
 IP66/IP68



TH406
 2 6 poles
 0.5 - 4.0 mm²
 6.0 - 14.0 mm
 M28
 IP68

Circular and Linear connectors

Number poles⁽¹⁾
 Wire cross-section
 IP protection degree

Fixed connectors (re-accessible)



TH029
 2 3 poles
 0.5 - 4.0 mm²
 IP00



TH032
 2 4 poles
 0.5 - 4.0 mm²
 IP00



TH112
 2 3 poles
 0.5 - 1.5 mm²
 IP54



TH021
 2 5 poles
 0.5 - 4.0 mm²
 IP20



TH033
 2 4 poles
 0.5 - 4.0 mm²
 IP00

Innovative cable glands in co-molding

Outer cable diameter⁽²⁾
 IP protection degree



TH450-451-452
 4.0 - 17.0 mm
 M16 - M20 - M25
 PG9 - PG13.5 - PG16
 IP68

mini-TEETUBE®: mini in-line circular joint connectors (IP68)



TH391



TH390

| External dimensions (mm) | N. Poles min - max | Wire cross section min - max (mm ²) | Outer cable diameter min - max (mm) | Code | Cable Type (not exhaustive) | Technical data | IP Grade | Series | Pieces/pack | Packs/box |
|--------------------------|--------------------|---|-------------------------------------|------------------------------|--|----------------|---------------|--------|-------------|-----------|
| ø23 x 68 | 2 - 3 - 4 | 0.5 - 4.0 | 5.0 - 12.0 | THB.391.A4A.R | max. 4G1.5 FG70R 4G1.5 - 3G2.5 - 2G4 H07RN-F | 32A - 450V | IP68 (30m/2h) | TH391 | 1 | 50 |
| ø23 x 85 | 2 - 3 - 4 | 0.5 - 4.0 | 5.0 - 12.0 | THB.391.R4A.R ⁽¹⁾ | | 17.5A - 450V | IP68 (30m/2h) | TH391 | 1 | 50 |
| ø32 x 82 | 2 - 3 | 0.5 - 4.0 | 5.0 - 13.5 | THR.390.S3D | max. 3G4 FG70R max. 3G4 H07RN-F | 32A - 450V | IP68 (50m/1h) | TH390 | 1 | 50 |

(1) xDRY product with the anti-condensation barrier (see page 4)

TEETUBE®: in-line circular joint connectors (IP68)



TH400

| External dimensions (mm) | N. Poles min - max | Wire cross section min - max (mm ²) | Outer cable diameter min - max (mm) | Code | Cable Type (not exhaustive) | Technical data | IP Grade | Series | Pieces/pack | Packs/box |
|--------------------------|--------------------|---|-------------------------------------|---------------|--------------------------------------|----------------|---------------|--------|-------------|-----------|
| ø26.5 x 115 | 2 - 3 | 0.5 - 4.0 | 6.0 - 13.5 | THR.400.S3D | max. 3G4 FG70R max. 3G4 H07RN-F | 32A - 450V | IP68 (50m/1h) | TH400 | 1 | 50 |
| ø32 x 130 | 2 - 3 | 0.5 - 4.0 | 8.0 - 17.0 | THB.400.D1N.R | max. 3G4 FG70R max. 3G4 H07RN-F | 32A - 450V | IP68 (50m/1h) | TH400 | 1 | 50 |
| ø32 x 130 | 2 - 3 - 4 | 0.5 - 4.0 | 6.0 - 17.0 | THR.400.A4D | max. 4G4 FG70R max. 4G4 H07RN-F | 32A - 450V | IP68 (50m/1h) | TH400 | 1 | 50 |
| ø32 x 130 | 2 - 3 - 4 | 2.5 - 6.0 | 12.0 - 20.0 | THR.400.S4E | max. 4G6 FG70R max. 4G6 H07RN-F | 41A - 750V | IP68 (50m/1h) | TH400 | 1 | 50 |
| ø32 x 130 | 2 - 3 - 4 - 5 | 0.5 - 4.0 | 6.0 - 17.0 | THR.400.S5D | max. 5G2.5 FG70R max. 5G4 H07RN-F | 32A - 450V | IP68 (50m/1h) | TH400 | 1 | 50 |

mini-TEETUBE®: mini circular junction connectors - 3/4 ways "H" (IP68)



TH392



TH392 (3 ways)

| External dimensions (mm) | N. Poles min - max | Wire cross section min - max (mm ²) | Outer cable diameter min - max (mm) | Code | Cable Type (not exhaustive) | Technical data | IP Grade | Series | Pieces/pack | Packs/box |
|--------------------------|--------------------|---|-------------------------------------|---------------------------------|--|----------------|---------------|--------|-------------|-----------|
| 28 x 54 x 80 | 2 - 3 - 4 | 0.5 - 1.5 | main 5.0 - 12.0 | THB.392.A4A.R ⁽²⁾ | max. 4G1.5 FG70R max. 4G1.5 H07RN-F | 17.5A - 450V | IP68 (30m/2h) | TH392 | 1 | 30 |
| | | | branch 5.0 - 12.0 | | | | | | | |
| 28 x 54 x 80 | 2 - 3 - 4 | 0.5 - 1.5 | main 5.0 - 12.0 | THB.392.R4A.R ⁽¹⁾⁽²⁾ | max. 4G1.5 FG70R max. 4G1.5 H07RN-F | 17.5A - 450V | IP68 (30m/2h) | TH392 | 1 | 50 |
| | | | branch 5.0 - 12.0 | | | | | | | |

(1) xDRY product with the anti-condensation barrier (see page 4)

(2) Closure cap included for 3 ways applications

TEETUBE®: circular junction connectors - 3 ways "T" (IP68)



TH390 "T"



TH402

| External dimensions (mm) | N. Poles min - max | Wire cross section min - max (mm ²) | Outer cable diameter min - max (mm) | Code ⁽¹⁾ | Cable Type (not exhaustive) | Technical data | IP Grade | Series | Pieces/pack | Packs/box |
|--------------------------|--------------------|---|--------------------------------------|----------------------|--|----------------|---------------|--------|-------------|-----------|
| ø32 x 92 x 73 | 2 - 3 | 0.5 - 1.5 | main 6.0 - 13.5 branch 6.0 - 13.5 | THR.390.S3T | max. 3G1.5 FG7OR max. 3G1.5 H07RN-F | 32A - 450V | IP68 (20m/1h) | TH390 | 1 | 50 |
| ø32 x 92 x 121 | 2 - 3 | 0.5 - 4.0 | main 6.0 - 13.5 branch 6.0 - 13.5 | THB.402.C2E.R | max. 3G4 FG7OR max. 3G4 H07RN-F | 32A - 450V | IP68 (20m/1h) | TH402 | 1 | 30 |
| ø32 x 92 x 121 | 2 - 3 - 4 | 0.5 - 1.5 | main 6.0 - 13.5 branch 6.0 - 13.5 | THB.402.C1D.R | max. 4G1.5 FG7OR max. 4G1.5 H07RN-F | 32A - 450V | IP68 (20m/1h) | TH402 | 1 | 30 |
| ø32 x 92 x 121 | 2 - 3 - 4 | 1.5 - 4.0 | main 6.0 - 13.5 branch 6.0 - 13.5 | THB.402.D4A.R | max. 4G2.5 FG7OR max. 4G2.5 H07RN-F | 32A - 450V | IP68 (20m/1h) | TH402 | 1 | 30 |
| ø32 x 92 x 121 | 2 - 3 - 4 - 5 | 0.5 - 1.5 | main 6.0 - 13.5 branch 6.0 - 13.5 | THB.402.C1F.R | max. 5G1.5 FG7OR max. 5G1.5 H07RN-F | 32A - 450V | IP68 (20m/1h) | TH402 | 1 | 30 |

TEETUBE®: circular junction connectors - 3 ways "Y" (IP68)



TH399 (mini)



TH399

| External dimensions (mm) | N. Poles min - max | Wire cross section min - max (mm ²) | Outer cable diameter min - max (mm) | Code ⁽¹⁾ | Cable Type (not exhaustive) | Technical data | IP Grade | Series | Pieces/pack | Packs/box |
|--------------------------|--------------------|---|--------------------------------------|----------------------|--|----------------|---------------|--------|-------------|-----------|
| ø32 x 63 x 125 | 2 - 3 | 0.5 - 1.5 | main 6.0 - 13.5 branch 6.0 - 13.5 | THR.399.S3C | max. 3G1.5 FG7OR max. 3G1.5 H07RN-F | 32A - 450V | IP68 (20m/1h) | TH399 | 1 | 50 |
| ø32 x 63 x 180 | 2 - 3 | 0.5 - 4.0 | main 6.0 - 17.0 branch 6.0 - 17.0 | THR.399.S9L | max. 3G4 FG7OR max. 3G4 H07RN-F | 32A - 450V | IP68 (20m/1h) | TH399 | 1 | 30 |
| ø32 x 63 x 180 | 2 - 3 - 4 | 0.5 - 1.5 | main 6.0 - 17.0 branch 6.0 - 17.0 | THB.399.D4A.R | max. 4G1.5 FG7OR max. 4G1.5 H07RN-F | 32A - 450V | IP68 (20m/1h) | TH399 | 1 | 30 |
| ø32 x 63 x 180 | 2 - 3 - 4 | 1.5 - 4.0 | main 6.0 - 16.0 branch 6.0 - 16.0 | THB.399.A4F.R | max. 4G4 FG7OR max. 4G4 H07RN-F | 32A - 450V | IP68 (20m/1h) | TH399 | 1 | 30 |
| ø32 x 63 x 180 | 2 - 3 - 4 - 5 | 0.5 - 1.5 | main 6.0 - 17.0 branch 6.0 - 17.0 | THR.399.S5L | max. 5G1.5 FG7OR max. 5G1.5 H07RN-F | 32A - 450V | IP68 (20m/1h) | TH399 | 1 | 30 |

(1) Closure cap to close a cable outlet included

mini-TEETUBE®: mini wall mount circular joint connectors (IP68)



TH391 (M25 nut)



TH391 (M20 nut)



Example

| External dimensions (mm) | N. Poles min - max | Wire cross section min - max (mm ²) | Outer cable diameter min - max (mm) | Code ⁽¹⁾ | Thread | Cable Type (not exhaustive) | Technical data | IP Grade | Series | Pieces/pack | Packs/box |
|--------------------------|--------------------|---|-------------------------------------|---------------------------------------|--------|---|----------------|---------------|--------|-------------|-----------|
| ø23 x 34 | 2 - 3 - 4 | 0.5 - 4.0 | 5.0 - 12.0 | THB.391.B4A.R⁽²⁾ | M20 | | 32A - 450V | IP68 (30m/2h) | TH391 | 1 | 50 |
| ø23 x 34 | 2 - 3 - 4 | 0.5 - 4.0 | 5.0 - 12.0 | THB.391.L4A.R | M25 | max. 4G1.5 FG70R 4G1.5 - 3G2.5 - 2G4 H07RN-F | 32A - 450V | IP68 (30m/2h) | TH391 | 1 | 50 |
| ø23 x 52 | 2 - 3 - 4 | 0.5 - 4.0 | 5.0 - 12.0 | THB.391.D4A.R⁽²⁾⁽³⁾ | M20 | | 17.5A - 450V | IP68 (30m/2h) | TH391 | 1 | 50 |
| ø23 x 52 | 2 - 3 - 4 | 0.5 - 4.0 | 5.0 - 12.0 | THB.391.T4A.R⁽³⁾ | M25 | | 17.5A - 450V | IP68 (30m/2h) | TH391 | 1 | 50 |

(1) Fixing nut included (2) Only for plastic panels or low voltage applications (3) xDRY product with the anti-condensation barrier (see page 4)



Transparent and colour versions upon customer request.



Compatible with cable protection systems and spiral tops.



Versions with over-molded cable upon customer request.



Special versions. Learn more on www.techno.it



Wide range of accessories for cables of various kind.

TEEBOX®: In-out junction box with terminal block (IP44)

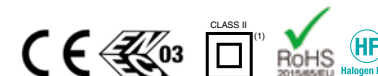

TH110 (2poles)



TH110 (3poles)

| External dimensions (mm) | N. Poles min - max | Wire cross section min - max (mm ²) | Outer cable diameter min - max (mm) | Code | Cable Type (not exhaustive) | Technical data | IP Grade | Series | Pieces/pack | Packs/box |
|--------------------------|--------------------|---|-------------------------------------|----------------------------|--|----------------|----------|--------|-------------|-----------|
| 75 x 39 x 13.5 | 2 | 0.5 - 2.5 | 5.0 - 9.0 | THR.110.S2A ⁽¹⁾ | max. 2G2.5 - 3G2.5 H05SS-F, H05VV-F, H05RR-F | 24A - 450V | IP44 | TH110 | 1 | 50 |
| 75 x 39 x 13.5 | 3 | 0.5 - 2.5 | 5.0 - 9.0 | THR.110.S3A | | 24A - 450V | IP44 | TH110 | 1 | 50 |

(1) Approved for use with class 2 devices

TEEBOX®: Junction boxes with terminal block - 3 ways "T" (IP65/IP67)



TH200



TH211

| External dimensions (mm) | N. Poles min - max | Wire cross section min - max (mm ²) | Outer cable diameter min - max (mm) | Code ⁽¹⁾ | Cable Type (not exhaustive) | Technical data | IP Grade | Series | Pieces/pack | Packs/box |
|--------------------------|--------------------|---|--------------------------------------|----------------------------|------------------------------------|----------------|----------|--------|-------------|-----------|
| 70 x 82 x 20 | 2 - 3 | 0.5 - 1.5 | main 2.5 - 9.5 branch 2.5 - 9.5 | THR.200.S3M ⁽²⁾ | max. 3G1.5 H07RN-F | 16A - 250V | IP67 | TH200 | 1 | 50 |
| 137 x 118 x 36 | 2 - 3 | 0.5 - 4.0 | main 6.0 - 13.5 branch 6.0 - 13.5 | THR.211.S3A ⁽²⁾ | max. 3G4 FG7OR max. 3G4 H07RN-F | 24A - 450V | IP65 | TH211 | 1 | 50 |
| 137 x 118 x 36 | 2 - 3 | 0.5 - 4.0 | main 8.0 - 17.0 branch 8.0 - 17.0 | THR.211.S3D | max. 3G4 FG7OR max. 3G4 H07RN-F | 24A - 450V | IP65 | TH211 | 1 | 50 |
| 137 x 118 x 36 | 2 - 3 - 4 | 0.5 - 4.0 | main 8.0 - 17.0 branch 8.0 - 17.0 | THR.211.S4D | max. 4G4 FG7OR max. 4G4 H07RN-F | 16A - 450V | IP65 | TH211 | 1 | 50 |

(1) Supplied with the terminal block (2) Closure cap to close a cable outlet included Note: versions with more poles available upon request. Learn more on www.techno.it

TEEBOX®: Junction boxes with terminal block - 3/4 ways "H" (IP68)



TH209



TH219

| External dimensions (mm) | N. Poles min - max | Wire cross section min - max (mm ²) | Outer cable diameter min - max (mm) | Code ⁽¹⁾⁽²⁾ | Cable Type (not exhaustive) | Technical data | IP Grade | Series | Pieces/pack | Pieces/box |
|--------------------------|--------------------|---|--------------------------------------|----------------------------|--|----------------|--------------|--------|-------------|------------|
| 108 x 65 x 28 | 2 - 3 | 0.5 - 4.0 | main 6.0 - 14.0 branch 6.0 - 14.0 | THB.209.A3A.R | max. 3G4 FG7OR max. 3G4 H07RN-F | 24A - 450V | IP68 (5m/3h) | TH209 | 1 | 50 |
| 108 x 65 x 28 | 2 - 3 - 4 | 0.5 - 2.5 | main 6.0 - 14.0 branch 6.0 - 14.0 | THR.209.A4A | max. 4G2.5 FG7OR max. 4G2.5 H07RN-F | 24A - 450V | IP68 (5m/3h) | TH209 | 1 | 50 |
| 108 x 65 x 28 | 5 | 0.5 - 1.5 | main 6.0 - 14.0 branch 6.0 - 14.0 | THR.209.S5L | max. 5G1.5 FG7OR max. 5G1.5 H07RN-F | 16A - 450V | IP68 (5m/3h) | TH209 | 1 | 50 |
| 108 x 65 x 28 | 8 | 0.5 - 1.5 | main 6.0 - 14.0 branch 6.0 - 14.0 | THR.209.S8L | max. 8G1 H07RN-F | 16A - 450V | IP68 (5m/3h) | TH209 | 1 | 50 |
| 108 x 65 x 28 | - | - | main 6.0 - 14.0 branch 6.0 - 14.0 | THR.219.A0A ⁽³⁾ | - | 16A - 450V | IP68 (5m/3h) | TH209 | 1 | 50 |

(1) Supplied with the terminal block (2) Closure cap to close a cable outlet included (3) Empty box to be filled with the resin (resin not included)

TEEBOX®: Pre-wired junction boxes with plug&socket connectors 3 ways "T" (IP65)



| External dimensions (mm) ⁽²⁾ | N. Poles min - max | Wire cross section min - max (mm ²) | Outer cable diameter min - max (mm) | Code ⁽¹⁾⁽³⁾ | Cable Type (not exhaustive) | Technical data | IP Grade | Series | Pieces/pack | Packs/box |
|---|--------------------|---|--------------------------------------|------------------------|--|----------------|----------|--------|-------------|-----------|
| 235 x 159 x 43 | 2 - 3 | 0.5 - 2.5 | main 6.0 - 14.0 branch 6.0 - 14.0 | THR.631.S3A | max. 3G2.5 FG70R max. 3G2.5 H07RN-F | 25A - 400V | IP65 | TH631 | 1 | 10 |
| 235 x 159 x 43 | 2 - 3 - 4 - 5 | 0.5 - 1.5 | main 6.0 - 14.0 branch 6.0 - 14.0 | THR.631.S5A | max. 5G1.5 FG70R max. 5G1.5 H07RN-F | 17.5A - 400V | IP65 | TH631 | 1 | 10 |

(1) Supplied with plug&socket connectors (2) Dimensions are intended when the connectors are inserted (3) Closure cap to close a cable outlet included

TEEBOX®: Pre-wired junction boxes with plug&socket connectors 4 ways "H" (IP68)



| External dimensions (mm) ⁽²⁾ | N. Poles min - max | Wire cross section min - max (mm ²) | Outer cable diameter min - max (mm) | Code ⁽¹⁾⁽³⁾ | Cable Type (not exhaustive) | Technical data | IP Grade | Series | Pieces/pack | Pieces/box |
|---|--------------------|---|--------------------------------------|------------------------|--|----------------|--------------|--------|-------------|------------|
| 200 x 65 x 28 | 2 - 3 | 0.5 - 1.5 | main 5.0 - 12.0 branch 5.0 - 12.0 | THR.623.B3A | max. 3G1.5 FG70R max. 3G1.5 H07RN-F | 17.5A - 400V | IP40 | TH623 | 1 | 10 |
| 200 x 65 x 28 | 2 - 3 | 0.5 - 2.5 | main 5.0 - 12.0 branch 5.0 - 12.0 | THR.623.S3A | max. 3G2.5 FG70R max. 3G2.5 H07RN-F | 17.5A - 400V | IP68 (5m/3h) | TH623 | 1 | 10 |

(1) Supplied with plug&socket connectors (2) Dimensions are intended when the connectors are inserted (3) Closure cap to close a cable outlet included



Colour and personalized versions upon customer request.



Transparent versions for easy check of the connection.



Hybrid and pre-wired solutions upon customer request.



Learn more about the TEEBOX® range on www.techno.it

mini-TEEPLUG®: mini plug&socket connectors (IP66/IP68)



TH387



TH384

| External dimensions (mm) ⁽¹⁾ | N. Poles min - max | Wire cross section min - max (mm ²) | Outer cable diameter min - max (mm) | Code ⁽⁴⁾ | Cable Type (not exhaustive) | Technical data | IP Grade | Series | Pieces/pack | Packs/box |
|---|--------------------|---|-------------------------------------|-------------------------------------|--|----------------|---------------------|--------|-------------|-----------|
| ø27 x 95 | 2 - 3 | 0.5 - 2.5 | 5.0 - 12.0 | THR.384.S3A ⁽³⁾ | max. 3G2.5 FG7OR max. 3G2.5 H07RN-F | 17.5A - 400V | IP66/IP68 (50m/24h) | TH384 | 1 | 50 |
| ø23 x 85 | 2 - 3 - 4 | 0.5 - 2.5 | 5.0 - 12.0 | THB.387.A4A.R ⁽³⁾ | max. 3G2.5/4G1.5 FG7OR max. 3G2.5/4G1.5 H07RN-F | 17.5A - 450V | IP68 (30m/3h) | TH387 | 1 | 50 |
| ø23 x 85 | 2 - 3 - 4 - 5 | 0.25 - 1.5 | 5.0 - 12.0 | THB.387.A5A.R | max. 5G1.5 FG7OR max. 5G1.5 H07RN-F | 17.5A - 450V | IP68 (30m/3h) | TH387 | 1 | 50 |

(1) Dimensions are intended when the connectors are inserted (2) UL approvals only for the TH384 series – 3 poles (learn more on www.techno.it)

(3) Approved for use with class 2 devices (only for 2 poles versions) (4) Plug and socket supplied together

TEEPLUG®: plug&socket connectors with safety lock-unlock system (IP68)



TH405

| External dimensions (mm) ⁽¹⁾ | N. Poles min - max | Wire cross section min - max (mm ²) | Outer cable diameter min - max (mm) | Code ⁽⁵⁾ | Cable Type (not exhaustive) | Technical data | IP Grade | Series | Pieces/pack | Packs/box |
|---|--------------------|---|-------------------------------------|--------------------------------------|--|----------------|---------------|--------|-------------|-----------|
| ø36.5 x 130 | 2 - 3 | 0.5 - 2.5 | 6.0 - 14.0 | THR.405.S3B ⁽³⁾⁽⁴⁾ | max. 3G2.5 FG7OR max. 3G2.5 H07RN-F | 25A - 400V | IP68 (10m/1h) | TH405 | 1 | 50 |
| ø36.5 x 130 | 2 - 3 - 4 - 5 | 0.5 - 1.5 | 6.0 - 14.0 | THR.405.S5A | max. 5G1.5 FG7OR max. 5G1.5 H07RN-F | 17.5A - 400V | IP68 (10m/1h) | TH405 | 1 | 50 |
| ø36.5 x 130 | 2 - 3 - 4 - 5 - 6 | 0.5 - 1.5 | 6.0 - 14.0 | THR.405.S6C | max. 6G1.5 FG7OR max. 6G1.5 H07RN-F | 17.5A - 400V | IP68 (10m/1h) | TH405 | 1 | 50 |

(1) Dimensions are intended when the connectors are inserted (2) UL approvals only for 3 and 5 poles (learn more on www.techno.it)

(3) Approved for use with class 2 devices (only for 2 poles versions) (4) Tested up to 32 Amp with 3G4 cable (5) Plug and socket supplied together

TEEPLUG®: plug&socket connectors (IP65)



TH404

| External dimensions (mm) ⁽¹⁾ | N. Poles min - max | Wire cross section min - max (mm ²) | Outer cable diameter min - max (mm) | Code ⁽³⁾ | Cable Type (not exhaustive) | Technical data | IP Grade | Series | Pieces/pack | Packs/box |
|---|--------------------|---|-------------------------------------|---------------------|--|----------------|----------|--------|-------------|-----------|
| ø42 x 130 | 2 - 3 | 0.5 - 2.5 | 6.0 - 14.0 | THR.404.S3B | max. 3G2.5 FG70R max. 3G2.5 H07RN-F | 25A - 400V | IP65 | TH404 | 1 | 50 |
| ø42 x 130 | 2 - 3 - 4 - 5 | 0.5 - 1.5 | 6.0 - 14.0 | THR.404.S5A | max. 5G1.5 FG70R max. 5G1.5 H07RN-F | 17.5A - 400V | IP65 | TH404 | 1 | 50 |
| ø42 x 130 | 2 - 3 - 4 - 5 - 6 | 0.5 - 1.5 | 6.0 - 14.0 | THR.404.S6C | max. 6G1.5 FG70R max. 6G1.5 H07RN-F | 17.5A - 400V | IP65 | TH404 | 1 | 50 |

(1) Dimensions are intended when the connectors are inserted (2) Approved for use with class 2 devices (only for TH404 series 2 poles) (3) Plug and socket supplied together

mini-TEEPLUG®: mini wall mount plug&socket connectors (IP66/IP68)



TH387



TH385

| External dimensions (mm) ⁽¹⁾ | N. Poles min - max | Wire cross section min - max (mm ²) | Outer cable diameter min - max (mm) | Code ⁽²⁾⁽³⁾ | Thread | Technical data | IP Grade | Series | Pieces/pack | Packs/box |
|---|--------------------|---|-------------------------------------|------------------------|--------------------|----------------|---------------------|--------|-------------|-----------|
| ø27 x 72 | 2 - 3 | 0.5 - 2.5 | 5.0 - 12.0 | THB.385.A3D.R | M20 | 17.5A - 400V | IP66/IP68 (50m/24h) | TH385 | 1 | 50 |
| ø23 x 55 | 2 - 3 - 4 | 0.5 - 2.5 | 5.0 - 12.0 | THB.387.L4A.R | M20 ⁽⁵⁾ | 17.5A - 450V | IP68 (30m/3h) | TH387 | 1 | 50 |
| ø23 x 55 | 2 - 3 - 4 - 5 | 0.25 - 1.5 | 5.0 - 12.0 | THB.387.L5A.R | M20 ⁽⁵⁾ | 17.5A - 450V | IP68 (30m/3h) | TH387 | 1 | 50 |
| ø27 x 72 | 2 - 3 | 0.5 - 2.5 | 5.0 - 12.0 | THR.385.S3A | M25 | 17.5A - 400V | IP66/IP68 (50m/24h) | TH385 | 1 | 50 |
| ø23 x 55 | 2 - 3 - 4 | 0.5 - 2.5 | 5.0 - 12.0 | THB.387.E4A.R | M25 | 17.5A - 450V | IP68 (30m/3h) | TH387 | 1 | 50 |
| ø23 x 55 | 2 - 3 - 4 - 5 | 0.25 - 1.5 | 5.0 - 12.0 | THB.387.E5A.R | M25 | 17.5A - 450V | IP68 (30m/3h) | TH387 | 1 | 50 |

(1) Dimensions are intended when the connectors are inserted

(3) Supplied with the fixing nut

(5) Only for plastic panels or low voltage applications

(2) Plug and socket supplied together

(4) UL approvals only for TH385 M25 3 poles (learn more on www.techno.it)

(6) Approved for use with class 2 devices: only for TH385 2 poles and TH387 2 poles (max. 250V)

With fixing nut



Colour and personalized versions upon request.



Transparent versions for easy check of the connection.



Versions with over-molded cable upon customer request.



Wide range of accessories for cables of various kind.

mini-TEEPLUG®: mini wall mount quick-fix plug&socket connectors (IP67)



TH386

Quick-fix system

| External dimensions (mm) ⁽¹⁾ | N. Poles min - max | Wire cross section min - max (mm ²) | Outer cable diameter min - max (mm) | Code ⁽²⁾ | Panel Hole (mm) | Technical data | IP Grade | Series | Pieces/ pack | Packs/ box |
|---|--------------------|---|-------------------------------------|---------------------|-----------------|----------------|----------|--------|--------------|------------|
| ø27 x 72 | 2 - 3 | 0.5 - 2.5 | 5.0 - 12.0 | THR.386.S3A | ø25 | 17.5A - 400V | IP67 | TH386 | 1 | 50 |

(1) Dimensions are intended when the connectors are inserted (2) Plug and socket supplied together

mini-TEEPLUG®: mini wall mount plug&socket connectors 90° angled (IP66/IP68)



TH385

With fixing nut

| External dimensions (mm) ⁽¹⁾ | N. Poles min - max | Wire cross section min - max (mm ²) | Outer cable diameter min - max (mm) | Code ⁽²⁾⁽³⁾ | Thread | Technical data | IP Grade | Series | Pieces/ pack | Packs/ box |
|---|--------------------|---|-------------------------------------|------------------------|--------|----------------|---------------------|--------|--------------|------------|
| ø27 x 35 x 100 | 2 - 3 | 0.5 - 2.5 | 5.0 - 12.0 | THB.385.A3F.R | M20 | 17.5A - 400V | IP66/IP68 (50m/24h) | TH385 | 1 | 50 |

(1) Dimensions are intended when the connectors are inserted

(3) Supplied with the fixing nut

(2) Plug and socket supplied together

(4) Approved for use with class 2 devices (only for 2 poles versions)

TEEPLUG®: mount plug&socket connectors (IP68)



TH406

With fixing nut

| External dimensions (mm) ⁽¹⁾ | N. Poles min - max | Wire cross section min - max (mm ²) | Outer cable diameter min - max (mm) | Code ⁽²⁾⁽³⁾ | Thread | Technical data | IP Grade | Series | Pieces/ pack | Pieces/ box |
|---|--------------------|---|-------------------------------------|------------------------|--------|----------------|---------------|--------|--------------|-------------|
| ø36.5 x 70 | 2 - 3 | 0.5 - 2.5 | 6.0 - 14.0 | THR.406.S3B | M28 | 25A - 400V | IP68 (10m/1h) | TH406 | 1 | 200 |
| ø36.5 x 70 | 2 - 3 - 4 - 5 | 0.5 - 1.5 | 6.0 - 14.0 | THR.406.S5A | M28 | 17.5A - 400V | IP68 (10m/1h) | TH406 | 1 | 200 |
| ø36.5 x 70 | 2 - 3 - 4 - 5 - 6 | 0.5 - 1.5 | 6.0 - 14.0 | THR.406.S6C | M28 | 17.5A - 400V | IP68 (10m/1h) | TH406 | 1 | 200 |

(1) Dimensions are intended when the connectors are inserted

(3) Supplied with the fixing nut

(2) Plug and socket supplied together

(4) UL approvals only for 3 and 5 poles (learn more on www.techno.it)

(5) Approved for use with class 2 devices (only for 2 poles versions)

mini-TEEPLUG®: mini plug&socket connectors with insulation piercing system (IP68)

For single-pole main cables



TH370

| External dimensions (mm) ⁽¹⁾ | N. Poles min - max | Main cable cross section min - max (mm ²) | Main cable diameter min - max (mm) | Outer cable diameter min - max (mm) | Code ⁽²⁾ | Technical data | IP Grade | Series | Pieces/pack | Packs/box |
|---|--------------------|---|------------------------------------|-------------------------------------|---------------------|----------------|----------|--------|-------------|-----------|
| 32 x 44 x 130 | 2 | 2.5 - 4.0 | 6.0 - 7.0 | 5.0 - 12.0 | THR.370.A2A | 17.5A - 400V | IP68 | TH370 | 1 | 50 |
| 32 x 44 x 130 | 2 | 4.0 - 6.0 | 7.0 - 8.0 | 5.0 - 12.0 | THR.370.B2A | 17.5A - 400V | IP68 | TH370 | 1 | 50 |

(1) Dimensions are intended when the connectors are inserted (2) Plug and socket supplied together

mini-TEEPLUG®: mini plug&socket ultra flat connector (IP67)



TH420

| External dimensions (mm) ⁽¹⁾ | N. Poles min - max | Main cable cross section min - max (mm ²) | Code ⁽²⁾ | Technical data | IP Grade | Series | Pieces/pack | Packs/box |
|---|--------------------|---|---------------------|----------------|----------|--------|-------------|-----------|
| 22 x 84 x 4 | 2 | 0.75 | THR.420.S2A | 6A - 230V | IP67 | TH420 | 1 | 50 |

(1) Dimensions are intended when the connectors are inserted (2) Plug and socket are supplied together

Note: plug and socket connectors are supplied with over-molded cable (H03V2V2-F, 2x0.75mm²). Cable length is 450 mm for both sides.



TH386. Quick fixing on circular or flat panel without the use of the fixing nut.



TH386. Pluggable installation when used in combination with TH384 connectors.



TH370. Quick installations of the main cable with the insulation piercing clip connector.



TH370. Pluggable installation of the branch cable when used in combination with TH384 connectors.

TEEDRUM®: mini compact circular connectors (IP20)



TH021

TH033

| External dimensions (mm) | N. Poles min - max | Wire cross section min - max (mm ²) | Code | Technical data | IP Grade | Series | Pieces/pack | Packs/box |
|--------------------------|--------------------|---|---------------|----------------|----------|--------|-------------|-----------|
| ∅22 x 26 | 2 - 3 | 0.5 - 4.0 | THR.021.S3A | 32A - 450V | IP20 | TH021 | 5 | 30 |
| 23 x 22 x 24 | 2 - 3 - 4 | 0.5 - 4.0 | THB.033.A4A.R | 32A - 450V | IP00 | TH033 | 5 | 30 |
| ∅26 x 26 | 2 - 3 - 4 - 5 | 0.5 - 4.0 | THR.021.S5A | 32A - 450V | IP20 | TH021 | 5 | 30 |

TEEBLOCK®: mini compact linear connectors (IP00)



TH026



TH029



TH027

| External dimensions (mm) | N. Poles min - max | Wire cross section min - max (mm ²) | Code | Technical data | IP Grade | Series | Pieces/pack | Pieces/box |
|--------------------------|--------------------|---|------------------------------|----------------|----------|--------|-------------|------------|
| 21 x 20.6 x 16.4 | 2 - 3 | 0.5 - 4.0 | THR.026.A3A | 32A - 450V | IP00 | TH026 | 5 | 30 |
| 30.6 x 20.6 x 15.8 | 2 - 3 | 0.5 - 4.0 | THR.029.S3A ⁽¹⁾ | 32A - 450V | IP00 | TH029 | 5 | 30 |
| 29 x 44 x 16 | 2 - 3 | 1.5 - 6.0 | THR.027.A3A | 41A - 450V | IP00 | TH027 | 1 | 50 |
| 50.7 x 20.8 x 21 | 2 - 3 - 4 | 0.5 - 4.0 | THB.032.A4B.R ⁽¹⁾ | 32A - 450V | IP00 | TH032 | 1 | 50 |
| 32 x 21 x 16.4 | 2 - 3 - 4 - 5 | 0.5 - 4.0 | THR.026.A5A | 32A - 450V | IP00 | TH026 | 5 | 30 |

(1) Current distributor with double connection (see page 17) *Note: TEEBLOCK® connectors are approved for use with stranded and solid cables*

TEEBLOCK®: mini compact in-out terminal block with crimp/screw connection (IP54)



TH112

| External dimensions (mm) | N. Poles min - max | Wire cross section min - max (mm ²) | Code | Technical data | IP Grade | Series | Pieces/pack | Pieces/box |
|--------------------------|--------------------|---|-------------|----------------|----------|--------|-------------|------------|
| 21 x 46.3 x 12.6 | 2 - 3 | 0.5 - 1.5 | THR.112.A3A | 17.5A - 450V | IP54 | TH112 | 1 | 50 |

Note: visit www.techno.it to learn more on crimp contacts usable with this product. See page 17 for more information on TH112

TEEGLAND®: innovative cable glands in co-molding (IP68)



| Thread | Colour | Outer cable diameter (mm) | Code ⁽¹⁾ | IP Grade | Series | Pieces/pack | Packs/box |
|--------|--------|---------------------------|---------------------|---------------|--------|-------------|-----------|
| PG9 | black | 4.0 - 9.5 | THR.450.S1A | IP68 (50m/1h) | TH450 | 5 | 50 |
| PG13.5 | black | 7.0 - 10.5 | THR.451.S1A | IP68 (50m/1h) | TH451 | 5 | 50 |
| PG13.5 | black | 10.5 - 14.0 | THR.451.S3A | IP68 (50m/1h) | TH451 | 5 | 50 |
| PG16 | black | 7.0 - 10.5 | THR.451.S5A | IP68 (50m/1h) | TH451 | 5 | 50 |
| PG16 | black | 10.5 - 14.0 | THR.451.S7A | IP68 (50m/1h) | TH451 | 5 | 50 |
| M16 | black | 4.0 - 9.5 | THR.450.S0A | IP68 (50m/1h) | TH450 | 5 | 50 |
| M20 | black | 7.0 - 10.5 | THR.451.S2A | IP68 (50m/1h) | TH451 | 5 | 50 |
| M20 | black | 10.5 - 14.0 | THR.451.S0A | IP68 (50m/1h) | TH451 | 5 | 50 |
| M25 | black | 7.0 - 10.5 | THR.452.S2A | IP68 (50m/1h) | TH452 | 5 | 50 |
| M25 | black | 10.5 - 14.0 | THR.452.S0A | IP68 (50m/1h) | TH452 | 5 | 50 |
| M25 | black | 14.0 - 17.0 | THR.452.S4A | IP68 (50m/1h) | TH452 | 5 | 50 |



| Thread | Colour | Outer cable diameter (mm) | Code | IP Grade | Series | Pieces/pack | Packs/box |
|--------|--------|---------------------------|--------------------|---------------|--------|-------------|-----------|
| PG9 | grey | 4.0 - 9.5 | THR.450.S1E | IP68 (50m/1h) | TH450 | 5 | 50 |
| PG13.5 | grey | 7.0 - 10.5 | THR.451.S1E | IP68 (50m/1h) | TH451 | 5 | 50 |
| PG13.5 | grey | 10.5 - 14.0 | THR.451.S3E | IP68 (50m/1h) | TH451 | 5 | 50 |
| PG16 | grey | 7.0 - 10.5 | THR.451.S5E | IP68 (50m/1h) | TH451 | 5 | 50 |
| PG16 | grey | 10.5 - 14.0 | THR.451.S7E | IP68 (50m/1h) | TH451 | 5 | 50 |
| M16 | grey | 4.0 - 9.5 | THR.450.S0E | IP68 (50m/1h) | TH450 | 5 | 50 |
| M20 | grey | 7.0 - 10.5 | THR.451.S2E | IP68 (50m/1h) | TH451 | 5 | 50 |
| M20 | grey | 10.5 - 14.0 | THR.451.S0E | IP68 (50m/1h) | TH451 | 5 | 50 |
| M25 | grey | 7.0 - 10.5 | THR.452.S2E | IP68 (50m/1h) | TH452 | 5 | 50 |
| M25 | grey | 10.5 - 14.0 | THR.452.S0E | IP68 (50m/1h) | TH452 | 5 | 50 |
| M25 | grey | 14.0 - 17.0 | THR.452.S4E | IP68 (50m/1h) | TH452 | 5 | 50 |

(1) Fixing nut included (black colour)



Colour versions available upon request.

Project references:

electrical connections under the most extreme conditions



Connection of LED industrial lighting for automotive industry (Germany).
Series TH405/TH406 (silicon free).



Connection of street lighting LED Luminaires (Rome, Italy).
Series TH405.



Connection of luminaires for Supertree Grove, Garden by the Bay (Singapore).
Series TH400.



Connection of facade lighting devices at Birmingham library (UK).
Series TH405/TH631.



Connection of LED luminaires (Penang, Malaysia).
Series TH387.



Connection of street lighting devices at F1 Grand Prix (Singapore).
Series TH405.



Connection of submersible pumps (France).
Series TH400.



Connection of lighting points on a sailing boat (New Zealand).
Series TH387.



Connection of LED luminaires in cold rooms on a FPSO vessel (Singapore).
Series TH387.



Connection of LED luminaires in a car washing plant (New Zealand).
Series TH387.



Wall mount connection on a control panel of a bottled water plant (Australia).
Series TH387.



Connection of liquid level sensors (Shanghai, China).
Series TH451.



Connection of generators for a server room UPS (New Zealand).
Series TH405.



Connection of motors (Germany).
Series TH450.



Connection of heating cables (France).
Series TH211.

International client experience

The industrial and creative process.

From its *client experience* Techno has developed the innovative, complete and customized solution for electrical connections.

**FUNCTIONAL_CREATIVITY +
FOREFRONT_TECHNOLOGIES +
INNOVATIVE_MATERIALS =
MORE RELIABLE AND AFFORDABLE SOLUTIONS**

The continuous analysis of the application conditions and operational modalities in the factory and site over the last 10 years have enabled Techno to develop specific solutions which have become off-the-shelf products. This results in higher quality together with cheaper installation, maximum reliability and easy maintenance.

Techno continues to offer customizable products and, at the same time, it has strengthened its designing and productive structure to developed ad hoc customized solutions. With an Italian design and all the positive characteristics of “made in Italy” products.

